

Instruction for use

- Small Interface Cable Adapter - **SICA16C20Z-GA101**

1. Product Overview

By using this adaptor to place a pad near the micro controller, it is expected to reduce the area related to tool connections on the print circuit board (user real machine).

This is a cable adaptor for conversion to the 0.5mm pitch small I/F, which corresponds to the structure where the 2.54mm pitch 16pin flat cable connector on the user real machine has a key slot opposite the development tool (ICE, flash writing adaptor, etc.: “Tools”).

- Connector footprint area
 - 1/5 of that required for a traditional connector(2.54mm pitch)
- Reduced wiring requirements for tool signals:
 - Can be moved from circuit board edge to the vicinity of the microcomputer
- Surface mounted, allows rear of target socket to be used

2. Specifications

2.1 Conditions for Use

Table 2-1 SICA16C20Z-GA101 Conditions for Use

	Parameter	In Use	Not in Use
1	Temperature	10 to 35°C	-10 to 50°C
2	Humidity	35 to 80% RH (no condensation)	
3	Chemical gas	No corrosive gas should exist in the environment	

2.2 Product Specifications

Table.2-2 Product Specifications

	Title	Specifications
1	Outward size	34mm x 100mm x 20mm
2	Emulator Connector	HIF3FC-16PA-2.54DSA(71) A key slot oriented to the target
3	Target Header	Custom made connector 20pin 0.5 mm pitch pogo pin
4	Cable material	FPC, polyamides, double layers
5	DC resistance	400m Ω or less (including the contact resistance of both connectors)
6	Insert/remove life span	500 times (when inserting/removing connectors vertically)
7	Rating current	0.2A/line or less

2.3 Package Contents

- SICA16C20Z-GA101 One piece
- How to handle SICA Notes One copy

2.4 Pad condition on the target side

- 1) Recommended foot pattern on target board

Please visit the following web site to get the target board footprint pattern.

http://www.tetc.co.jp/pdf/sica_zumen/footprint_sica2p20s.pdf

3. How to use the Cable Adapter

Ensure that the power supplies to both the tool and target boards are turned off, then follow the procedure described below to connect the cable adapter.

1. Connect the target cable from the tool to the SICA tool connector (see Fig 3.1)

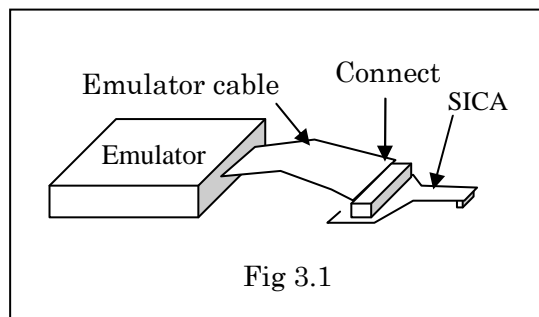

A polarity key prevents the user to plug the emulator cable and the SICA together in the wrong direction as shown in Fig 3.2

Check the key's position before assembling the header and the socket.

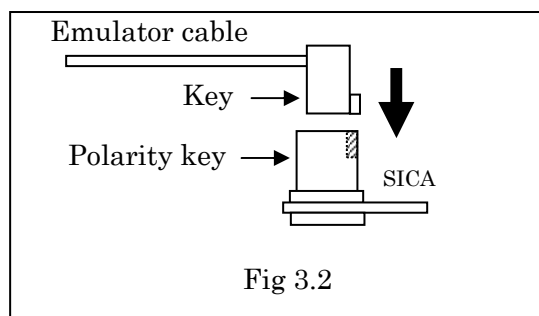

2. Position this product to the pad on the target board along the guide, and then apply downward load so that it touches with the board. (Fig 3.3)

A reverse connection may damage the device. Please be sure that the pattern is oriented correctly.

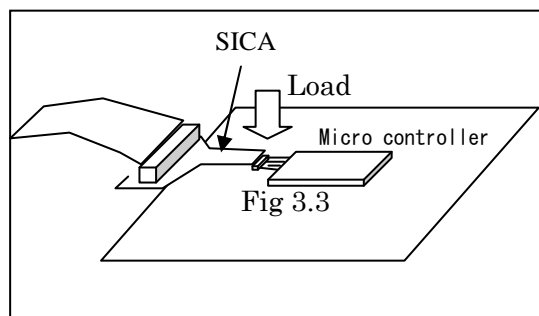

2. Cable wiring diagram

Cable wiring diagram is shown in Fig 4.1.

Triangle mark indicates pin#1. The pin#1 on the SICA connected to pin#1 on the other end. That is, pins are connected to straight across the cable.

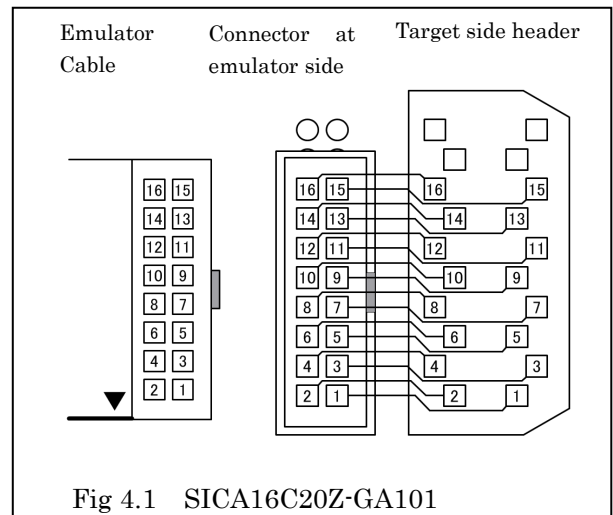

1. Cautions for handling SICA - Small Interface Cable Adapter -

- 1) This cable adapter is intended for use during system development and testing.
It has not been certified under the electrical product safety laws or for electromagnetic interference.
- 2) This cable adapter is not designed or manufactured for use in equipment or systems on which human lives may depend. Do not use in critical applications such as transport equipment, medical devices, aeronautical or space equipment, or nuclear reactor control.)
- 3) Refer to this user guide and to the manuals provided with the development tool you are using when designing your user system or connecting the user system to this cable adapter. In particular, check the pin numbers and ensure that they are connected correctly. Note that some development tools may use non-standard pin numbering. This adapter performs a one-to-one conversion between the two connector types and the pin numbering may not be the same as the numbering on the connector terminal from your development tool. When using this cable adapter, please ensure that you fully understand the requirements described in the manual for your development tool or elsewhere.)
- 4) Do NOT bend flex cable too sharply, because it might break the internal conductive trace. Insert or extract the cable with using the stiffener.

The information in this document is subject to change without notice.

Tokyo Eletech Corporation 3-10 Akihabara, Taito-ku, Tokyo, 110-0006, Japan TEL : +81-(0)3-5295-1661 FAX : +81-(0)3-5295-1775 URL : http://www.tetc.co.jp/ E-Mail : e-components@tetc.co.jp
--