

Detail of A

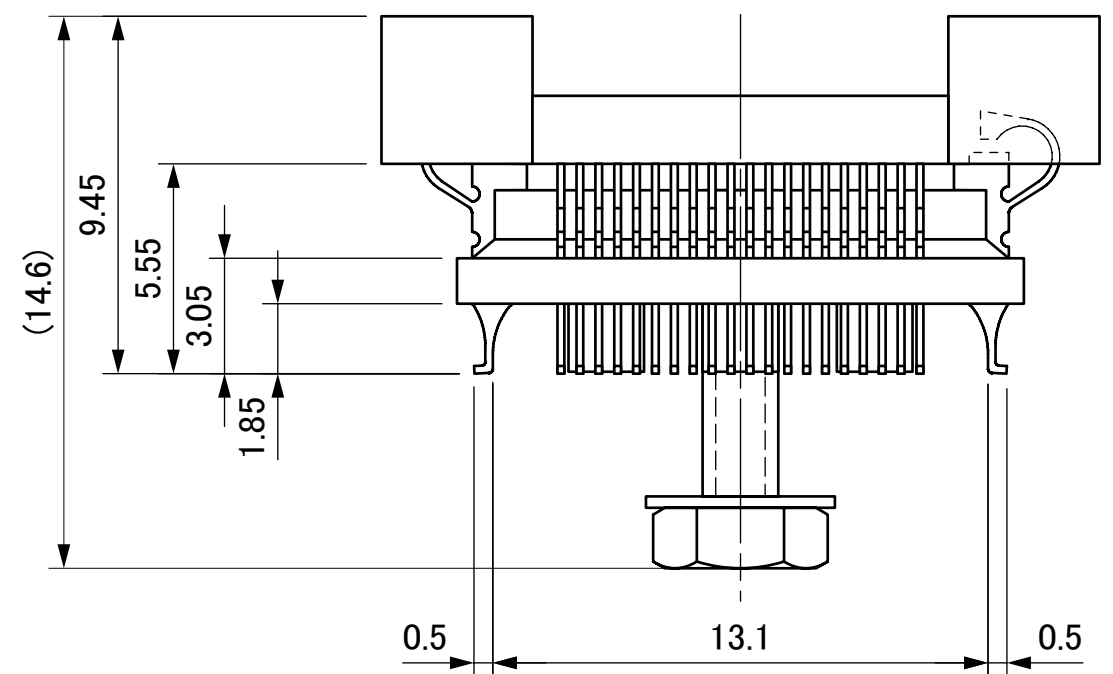

Part No.	NQPACK080SD-ND-SL
IC package	Square
Pin count	80Pin
Lead pitch	0.5mm
Unit	mm
Design / Date	H.Suzuki/May.16.'06
TET TOKYO ELETECH CORP.	