

4-ø2.0 (A projection height : 1.8mm)

BOTTOM VIEW

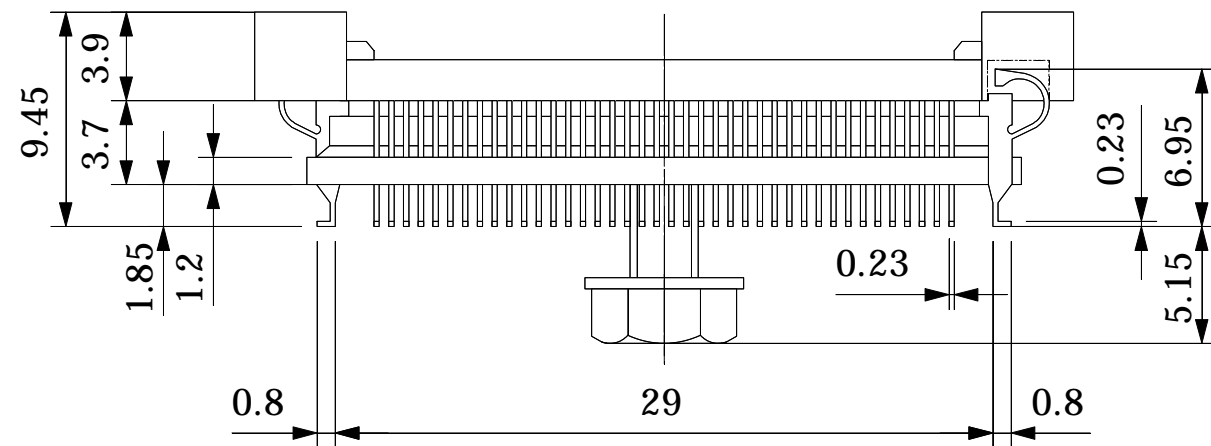

Part No.	NQPACK168SB-SL	
IC package	Square	
Pin count	168Pin	
Lead pitch	0.65mm	
Unit : mm		Design : M.H
TET TOKYO ELETECH CORP.		