

BOTTOM VIEW

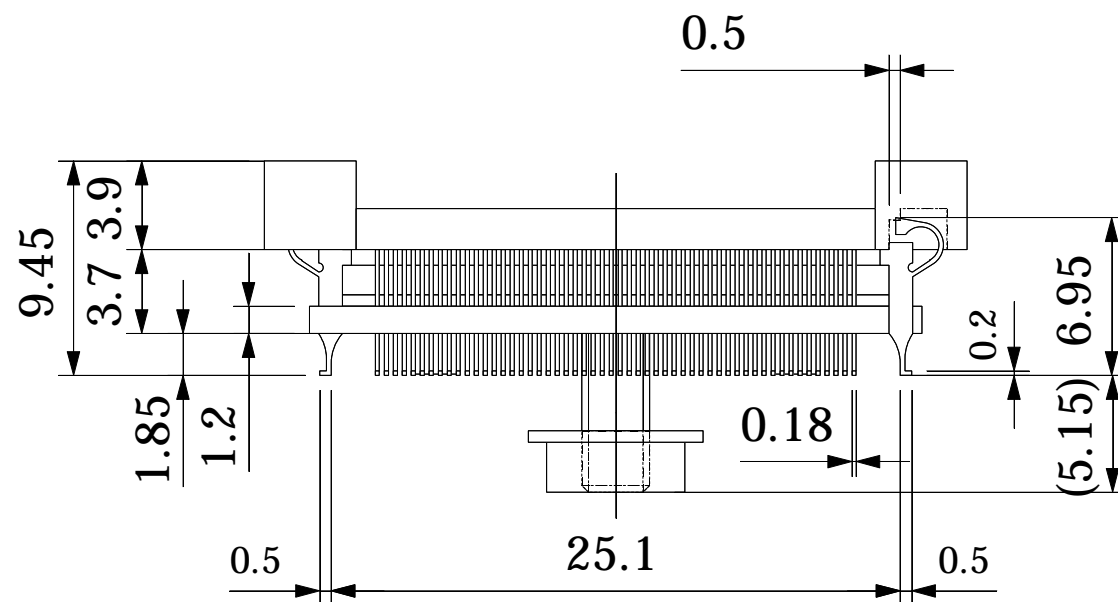

Part No.	NQPACK216SE-SL	
IC package	Square	
Pin count	216Pin	
Lead pitch	0.4mm	
Unit : mm	Design : M.H	
TET TOKYO ELETECH CORP.		