

**BOTTOM VIEW**

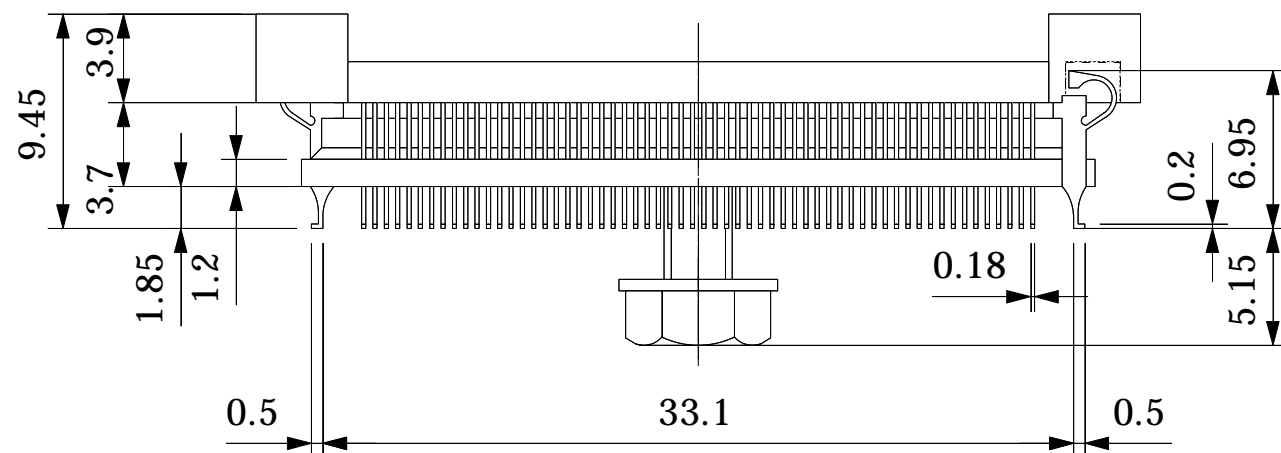

Part No.	<b>NQPACK240SD-SL</b>	
IC package	Square	
Pin count	240Pin	
Lead pitch	0.5mm	
Unit : mm	Design : M.H	
<b>TET</b> TOKYO ELETECH CORP.		